

# Preform Gravity 2 - 10 g



## TECNICAL SPECIFICATION

**DESCRIPTION** PREFORM Gravity 2 - 10 g

**NECK TYPE** Gravity 2

**WEIGHT** 10 g

**NECK WEIGHT** 2.05 g

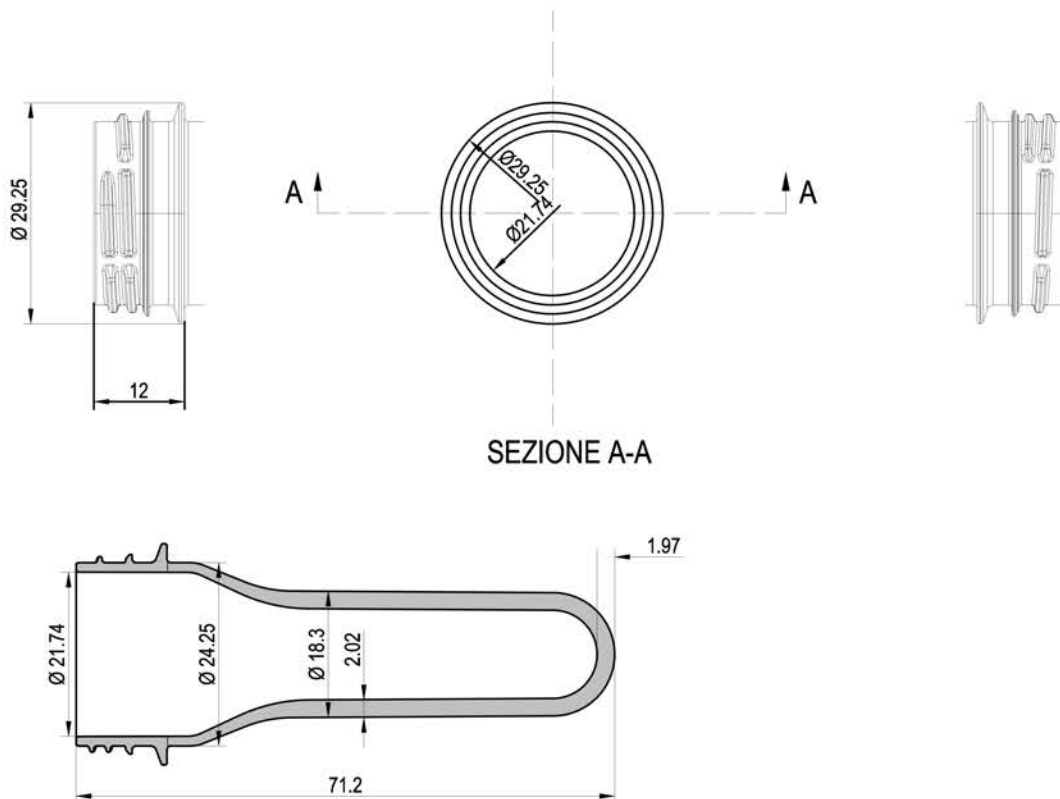

**MATERIAL** PET / R - PET

**SPECIFIC WIEGHT** 1.335 g/cm<sup>2</sup>

**PACKAGING** Pallet 100x120 cm - 120x120 cm  
Octabin 120x120x118 cm - 100x120x118 cm  
Polyethylene bag 200x250 cm - 190+20+20x250 cm

**STORAGE** Store the product in a dry place not exposed to sunlight  
Maximum number of stackable Octabins 3  
Before use, store for 24 hours in a room at a temperature between 18 ° -40 ° C  
Use the product within 12 months from the date of receipt

**NOTE**